



PRIMEPLUS® B1750  
BARIATRIC BED FRAME  
OWNER'S MANUAL

## **STANDARD CONVENTIONS USED IN THIS MANUAL**

Note: The information within this document is subject to change without notice. This manual includes important information about safety of personnel and equipment. As you read through this manual be aware of the four signal terms.



### **DANGER**

Information that appears under the DANGER description concerns the protection of personnel from direct and pending hazards that, if not avoided, will result in immediate, serious personal injury or death in addition to damage of the equipment.



### **WARNING**

Information that appears under the WARNING description concerns the protection of personnel from possible hazards that can result in injury or death in addition to damage of the equipment.



### **CAUTION**

Information that appears under the CAUTION description concerns the protection of personnel from possible hazards that may result in minor injury or damage of the equipment.

### **NOTE**

Information that appears under the NOTE description gives added information, which helps in understanding the item being described.

**Standard Features**

80"-88" Sleep Surface  
Travel Range: 15¼"-28¾"  
Width Extension: 39"-48"  
Locking System: 5" Locking Casters  
Pendant Connection on left and right sides  
Slat Deck  
Heavy Duty Casters  
Mattress Retainers  
Soft Gray Powdered Coated Frame Color  
Length Extension  
Wall Guard  
Side Rails  
Primus Medical Bed End Panels

**Accessories and Options**

39" Wide Pressure Reduction or Low-Air-Loss Mattress  
42" Wide Pressure Reduction or Low-Air-Loss Mattress  
48" Wide Pressure Reduction or Low-Air-Loss Mattress  
42" Mattress Expander Overlay  
Extra Side Rails  
Prime Mat  
Battery Back-Up  
Trapeze and Adapter

**Bed Frame Serial Numbers**

When ordering parts or when contacting Primus Medical Customer Service Department, please include bed's model and serial numbers, found on the identification labels. The identification labels are located under the sleep deck and can be found on the frame rail below the head section on either side of the bed.

## TECHNICAL SPECIFICATIONS

Overall Length (with head & foot boards)	92"
Overall Width*	40½"
Overall Width with extension to 1 <sup>st</sup> pins	39"
Overall Width with extension to 2 <sup>nd</sup> pins	42"
Overall Width with extension to 3 <sup>rd</sup> pins	48"
Length of mattress deck	80"-88"
Mattress deck height (low position)	15¼"
Mattress deck height (high position)	28¾"
Trendelenburg capable	No
Reverse Trendelenburg capable	No
Pendant connections on both sides of bed	Yes
Weight of bed**	423 lbs.
Maximum weight capacity***	750 lbs.
Input Voltage	120 V
Actuator Voltage	24 V

\*With side rails

\*\*Without mattress or side rails

\*\*\*This includes the weight of the resident/patient and all other accessories including, but not limited to mattresses, head/foot boards, assist rails, etc.

## SAFETY

### NOTICE:

The information contained in this document is subject to change without notice.

DO NOT operate this product without first reading and understanding this user manual. Damage or injury may result from improper use of this product.



DO NOT plug anything into housing components of bed (pendants or actuators) while power cord is plugged into the wall outlet.

Any cords or tubing used on or with this bed **MUST** be routed and secured properly to ensure that they do NOT become entangled, kinked or severed during normal operation of the bed.



DO NOT use near explosive gases.



Possible Fire Hazard if the use of nasal mask in ½ bed tent O<sub>2</sub> administering equipment. If O<sub>2</sub> tent is being used it should not fall below mattress deck. The pendant should not be placed in oxygen enriched environment such as an O<sub>2</sub> tent.

**Possible Injury or Death may occur if replacement parts are not provided by Primus Medical, LLC on any Primus Medical bed.**

**Possible Injury or Death may occur if accessories are not provided by Primus Medical, LLC for Primus Medical beds. Please contact Primus Medical for accessories that are compatible before use of bed.**

Caution-This bed frame complies with EMC requirements of IEC 60601-1-1. Radio transmitting equipment, cell phones or similar electronic devices, used in proximity of the bed, may affect the beds performance.

DO NOT roll the bed over any power or pendant cords.

Keep all moving parts free of obstructions.

DO NOT use assist rails as handles for moving the bed, use the Push/Pull Bars at each end of the bed.

NEVER exceed the weight limit of your bed (combined weight of user and items on bed). Exceeding weight limit may cause bed to fail.

Body weight should be evenly distributed over the sleeping surface of the bed. Avoid situations where entire body weight is on a raised head or foot surface. This includes while assisting the user in repositioning or transferring in or out of bed.

NEVER allow anyone under the bed at any time.

Supervision is required when this product is operated by or near children or people with disabilities.

Ensure that the individual using this bed is properly positioned, particularly when the bed is being operated or moved.

DO NOT let any body parts protrude over the side or between parts, especially when the bed is being moved or operated.

Caster locks shall be used except when bed is being moved.

This bed is equipped with a three-prong grounding plug for protection against possible shock hazard. DO NOT under any circumstances cut or remove the grounding prong.

DO NOT open any actuators, control boxes or pendants. Service is only to be performed by authorized service personnel. If unauthorized service is performed on any components the warranty is void.

Possible Injury may occur if bed is not kept in lowest position except when care is being provided. Bed should be at lowest suitable height for entry and exit.



Possible Injury or Death may occur due to pendant cord being a source for entangling patient/resident. Patients/residents with decreased mental acuity should NOT have access to pendant.

Possible Injury or Death may occur if bed is pushed over abrupt thresholds while bed is occupied. This bed was not designed to transport patients.

## **EMERGENCY EVACUATION**

- If your mattress has Velcro side bolsters remove those
- Push in extension buttons in
- Slide extensions in towards the center of the bed
- Perform this procedure on both sides of the bed
- The bed is now at 42" wide and can be used to evacuate patient out of the facility



## **ENTRAPMENT WARNING**

Accurate assessment of the patient and monitoring of correct maintenance and use of equipment are required to prevent entrapment. For additional information on product and safety issues for bed frames and rails refer back to product manuals. If bed frames have been serviced or any other adjustments have been made, make sure all parts are securely back in place before operating the bed frame. Other manufacturers assist rails may not be compatible and can lead to entrapment issues or harm to patients. Make sure mattress is the correct size for bed frame and the assist rails are secure to frame to decrease the risk of entrapment.

## **PRIMUS MEDICAL COMPLIANCE INFORMATION**

Matching the correct bed components to meet regulatory specifications can be complicated. Primus Medical offers a wide variety of compliance options. Primus Medical can assist your facility in selecting correct components or accessories that is recommended for the specific bed model.

## **MATTRESS SPECIFICATIONS**



### **WARNING**

- Possible ENTRAPMENT Hazard may occur if you do not use the recommended specification mattress.
- Resident entrapment may occur leading to injury or death.

A mattress may not be included with this bed. It is recommended that a wide mattress that is made to fit the width and length of a bed frame is used, such as a Primus Medical Redistribution Mattress. Primus Medical has 39", 42" and 48" Pressure Redistribution and Low-Air-Loss Mattresses to fit the width extension of the PPB2000. This mattress must be a minimum of 5 ½ inches and maximum of 8 inches. Also available is the EXP42 Mattress Expander Overlay which converts any 35" x 80" foam mattress to a 42" x 80" Pressure Redistribution Mattress when the 42" Width Extension is in place.

## UNPACKING INSTRUCTIONS (tools needed: Pliers or Wire-cutters)



DAMAGE to the equipment may occur if the zip ties are removed wrong.

- Package should be received on a pallet covered by a box.
- Cut black strapping around box; remove box enclosing bed frame.
- It may be necessary for two or more people to remove the bed from the pallet.
- After the bed is removed from the pallet there will be a box with the side rails, mattress retainers, wall guard and head/foot board in it.
- Remove ties from pendant. Before plugging the pendant into the bed frame cut the black “O” ring at the end of the pendant so it will snap into the pendant housing and fit securely into the bed frame.
- Remove any remaining zip ties or foam left on bed frame.
- Locate power cord and plug into grounded 110-120V outlet.
- Raise the bed frame and check to make sure everything is plugged into the control box and no wires are loose. If wires are not in control box, match up by the color coded system. (See instructions below)

**NOTE:** DO NOT remove zip ties that are holding any cords underneath bed frame.

## ASSEMBLY

**Tools Needed:** ¾” Wrench or Socket  
5/16” Hex Key  
3/16” Hex Key  
Phillips Screwdriver

5/32” and 7/32” Hex Key  
14mm Wrench and Socket  
Needle Nose Pliers

## MATTRESS RETAINER ADJUSTMENT

**All mattress guards are shipped upside-down and on reversed sides for shipping purposes.** These will need to be correctly placed along the bed to ensure proper function. Carefully slide out front and rear mattress guards and reinsert on opposite sides facing the guards in an upright position. Depress the center release button and slide the rail completely out. Reinsert right side up on opposite side as shown. **See below for proper placement.**



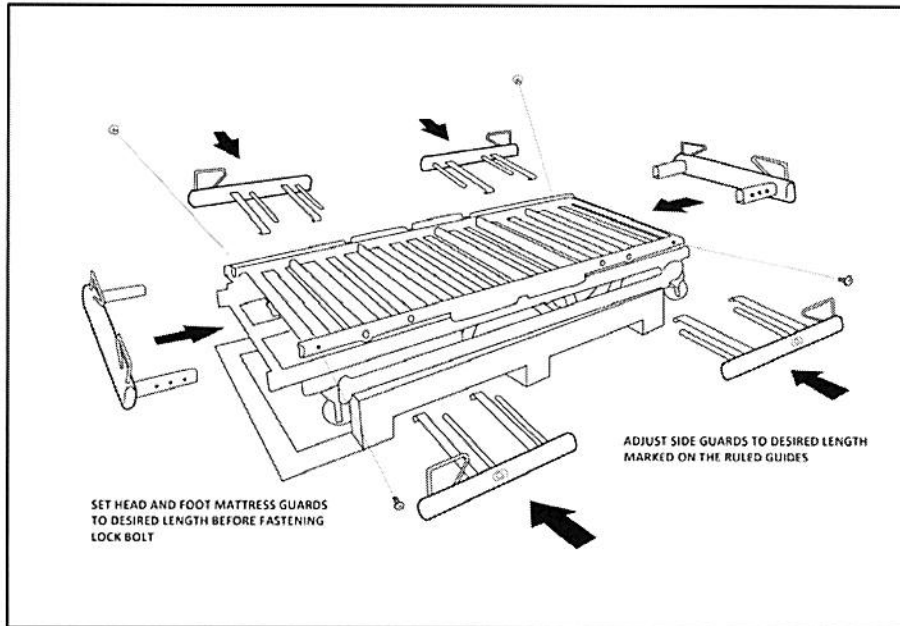

**Note:** Location of the head and foot mattress guards as well as the location of the side guards. Adjust all guards to the desired length and fasten head and foot guards using (4) of the small hex button head bolts and your 3/16 hex key wrench. **Correct guard placement shown below.**

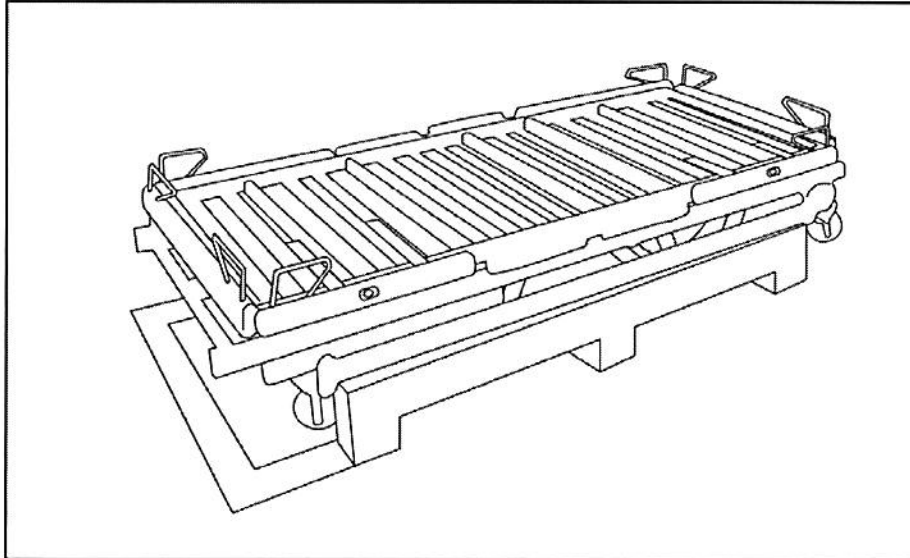

## HEADBOARD AND FOOTBOARD INSTALLATION AND ADJUSTMENT

**NOTE:** Phillips Screwdriver is required for initial mounting of headboard and footboard support assemblies.

- Using a Phillips Screwdriver, bolt the head and foot board to the mounting brackets.
- Unscrew knobs on each side of support assembly at both ends of the bed frame.

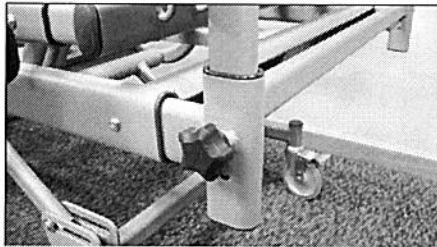

- Place the mounting brackets of the headboard/footboard into the slots of the support assembly.

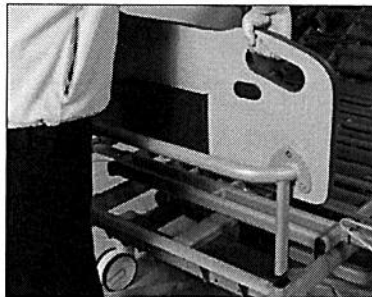

**NOTE:** The mounting bracket on the foot board should have the push/pull bar facing away from the bed.

- Slide headboard/footboard down until it stops.

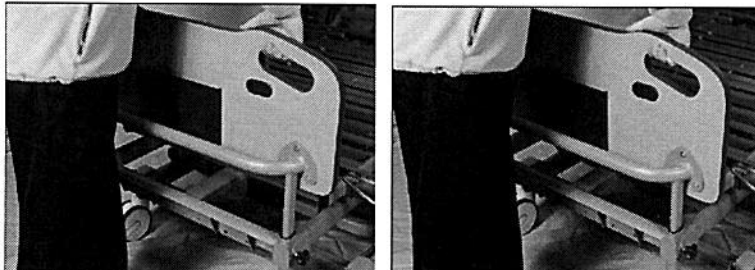

- Screw the knobs back in on each side of the support assembly to lock the headboard/footboard in position.

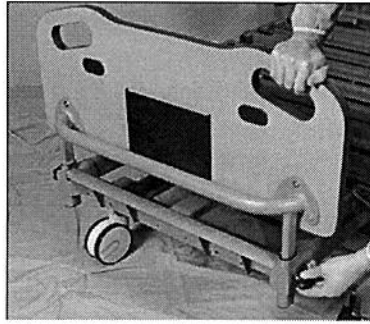

**SIDE RAIL ASSEMBLY** (Tools needed: 5/16", 5/32" Hex key and 3/4" Wrench and Socket )

- Remove the protection paper that is around the side rails by removing the (4) bolts on the back of the side rails using 5/32" hex key. Remove the paper and place the bolts back onto the side rails. Do this for both side rails. The side rails are now ready to be assembled on the bed frame.
- Locate side rail retainer on each side of the bed frame.

**NOTE:** Use this as a guide to place side rails in correct spot.

- Place side rail on side of bed with one end into the side rail retainer.
- The holes on the bracket of the side rail should fall below mattress deck.
- Slide a washer onto a 1/2" bolt and insert the bolt as shown.
- Use a 3/4" Wrench and Socket to tighten the bolt.
- Repeat the previous step for the remaining bolts for the side rails.

**NOTE:** It is normal to have some play in the side rail.



Patient entrapment with side rails may cause injury or death. To prevent patient entrapment the mattress must fit the bed frame and side rails snugly. Please follow the manufacturer's instructions and monitor patient frequently. Please read and understand the owner's/operator's manual prior to using this bed.

If rail is positioned incorrectly this may result in PATIENT ENTRAPMENT. To prevent PATIENT ENTRAPMENT the rail needs to be placed in the correct area, use the side rail retainer as your guide.

## WIDTH EXTENSION (No tools needed)

- Choose which width the bed needs to be extended to.
- This width extension expands by using the push button mechanism.

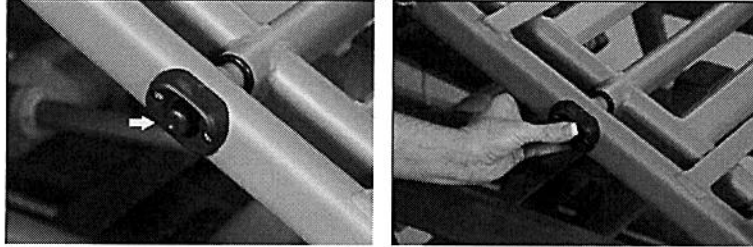

- If the extension is pulled out to the first sticker on the slat it will read 39”.

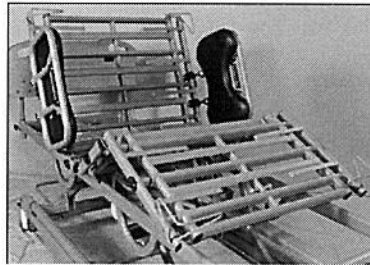

- If the extension is pulled out to the second sticker on the slat it will read 42”.



- The next sticker on the slat will be 48”.



- Push the expansion button mechanism in and pull out extension until you reach what width the bed frame needs to be set at.
- If the extension slats are pulled all the way out they are at 48” wide.

**Note:** This bed expands from 37" to 48" wide and it is HIGHLY recommended that a mattress be used, such as a Primus Medical Redistribution Mattress.

#### **LENGTH EXTENSION (3/16" Hex Key Needed)**

- This bed frame can be extended from 80" to 84" to 88" in length. Determine what the bed frame needs to be set at.
- If the bed frame needs to be set at the 80" length there is no need to adjust the length extension.
- If the bed frame needs to be set at the 84" length the head and foot section needs to be extended out to the second hole placement.
- If the bed frame needs to be set at the 88" length the head and foot section needs to be extended out to the third hole placement.

**NOTE:** This bed extends from 80" to 88" in length and it is HIGHLY recommended that the mattress length accommodates the length of the bed, such as a Primus Medical Redistribution Mattress. A Gap Fill may also be used to fill in the area at the end of the bed frame so Entrapment Issues are avoided.

#### **WALL GUARD (Not tools needed)**

**NOTE:** To install wall guard locate the mount on the cross bar under the head of the bed.

- Place the Wall Guard into the holes of the mount underneath the bed.

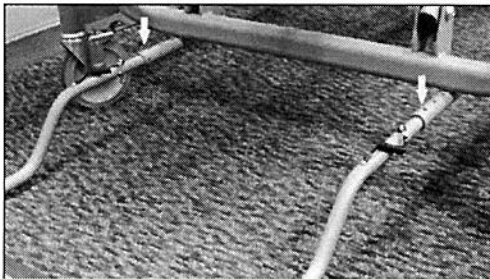

- Place pins on each side of the bar into the holes to keep the Wall Guard in place.

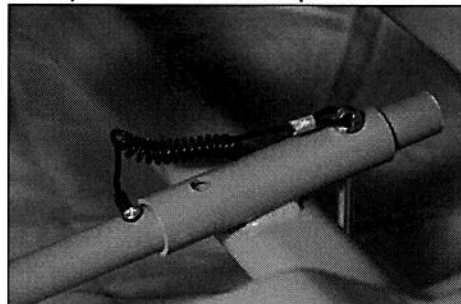
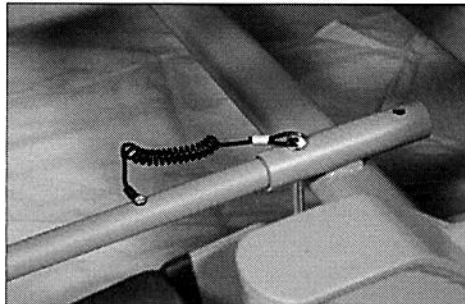

- The Wall Guard should now be in place.

## BED FUNCTIONS

### Hand Control Operation

#### 5 Function Hand Pendant

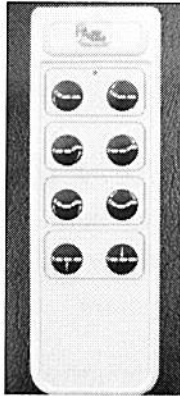

- This pendant can be plugged into the left or right side of the bed for the convenience of the patient.
- The top buttons control the raising and lowering of the head section.
- The 2<sup>nd</sup> set of buttons control the raising and lowering of the foot section.
- The 3<sup>rd</sup> set of buttons controls the auto contour.
- The 4<sup>th</sup> set of buttons control the raising and lowering of the bed frame.

**NOTE:** When operating the hand control, make sure that the lockout function is off, that is when the light next to the unlocked lock is on.

#### Power Cord Storage

- Power cord strain relief located underneath the bed frame at the head of the bed keeps the power cord off the floor and protects the power cord from getting severed or ran over.

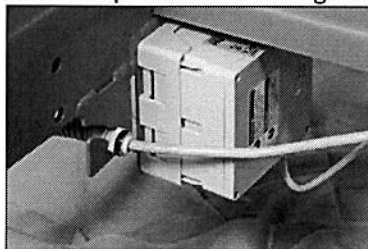

## Bed Mobilization and Stabilization



### WARNING

Involuntary bed movement may take place if the bed casters are left unlocked. Involuntary bed movement may lead to property DAMAGE or resident INJURY. Never leave a bed unattended while the casters are unlocked.

### Caster Lock

- To lock the bed use any of the four foot locks above the casters.



- To lock the bed frame, push down on all 4 locks on the casters with your foot.

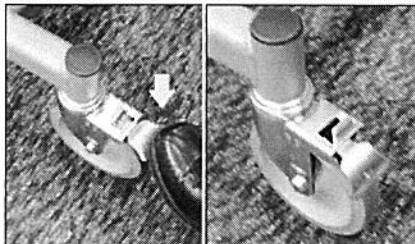

- To unlock the bed frame, push up on all 4 locks on the casters with your foot.



### CAUTION

Moving the bed while the casters are lock is engaged may cause DAMAGE to the bed. Do not move the bed until the caster lock is unlocked.

## CARE AND MAINTENANCE

### Cleaning Method



Equipment or property DAMAGE or resident INJURY may take place during maintenance.

### Cleaning Instructions

- Prior to cleaning unplug power supply.
- Make sure all electrical parts (motors, control boxes and pendant) are not broken and all housing components are plugged. Ensure that NO liquids enter electrical components.
- Sanitize and wash all components. DO NOT submerge the bed frame or electrical components.
- Use standard water pressure. DO NOT power wash or steam clean any parts.
- Rinse completely with water (Maximum temperature 110°F or 43°C). Solvents, alcohol, or petroleum should not be used on the bed surface.
- Make sure all parts are dry before using or storing.



Failure to take care of your bed may decrease the life of your product and increase product maintenance.

## INITIAL INSPECTION

### Inspection of All Components – Receipt of assembled bed

- Check bed components for obvious damage.
- Inspect power supply cords for cuts and/or damage.
- Check that actuator cords are connected properly to the controller.

### Annual Inspection

#### Mattress Support Surface, Frame and Base Assemblies

- Inspect welds on the mattress support surface, frame and base assemblies for stress fractures.
- Verify all fasteners are tight.
- Inspect fasteners for wear or damage.

#### Actuators

- Inspect push tubes and end connections of all actuators for excess wear or bending.



- Verify that all clevis pins are in place.

#### Casters

- Check that locks on casters lock properly (if equipped).
- Check that all casters roll properly.
- Check bed brake mechanism for proper function (roll at any height model).
- Check caster alignment mechanism to verify proper function (roll at any height model).

#### Semi-Annual Inspection

##### Control Box

- Check power cord for chafing, cuts or wear.
- Make sure all attachment hardware and brackets are tight.
- Check electrical connections for wear or fractures.
- Verify that all actuator connections are tight.

##### Pendant

- Check pendant cord for chafing, cuts or wear.
- Check all pendant buttons for proper function.

##### Actuators

- Check actuator cords for chafing, cuts or wear.
- Check to make sure actuators do not bind at any point throughout their full range of motion.

##### Authorized Accessories

- Inspect all fasteners for looseness and wear. Replace or tighten as necessary.
- Ensure proper function of accessory.
- Ensure welds do not have stress fractures.
- Ensure no tubes are bent.

#### Quarterly Maintenance Check

If the bed has a battery, unplug from the wall outlet and validate function. The battery may be built-in or portable.

- Inspect bed and Assist Bars/Rails bolts, if loose tighten and if missing replace.
- Lubricate clevis pins at hinge points.
- Lubricate tracks of bed for smooth travel.

## **Servicing**

Actuators and Control Box are light gray.

Possible Shock Hazard may occur if the Control Box is not unplugged from the wall outlet before any maintenance is performed on Motor or Control Box.

### **Motor and Control Box Information**

#### **Cord and Socket Identification**

- Staff Control (Green)
- Hand Pendant (Red)
- Head Section Motor (Black)
- Foot Section Motor (Yellow)
- Hi/Lo Motor (Blue)
- Hi/Lo Motor (White)
- Battery Back-Up (Black)

#### **Removing Control Box**

- Unplug main power supply from the wall outlet.
- Disconnect the power cord from the control box.
- Disconnect the color coded wires from the control box.
- Disconnect the ground wire from the control box by loosening the brass nut on the control box and removing the wire.
- Locate the retention collar holding the control box to the actuator.
- Slide the collar toward the head of the bed.
- Pull the control box away from the bed.
- The control box should now be free.
- The outlets on the control box are color coded so they can be reinstalled later.

#### **Removing the Actuator/Motor**

- Identify the motor that needs to be replaced.
- Tip bed on its side to remove the Hi/Lo motors.
- Unplug motor cord from control box.
- Motor is held in place by (2) cotter pins.
- These can be removed with your fingers.
- Slide pins out of holes — they should come out easily.

#### **Removing the Power Cord (Flat Head Screwdriver Needed)**

- Locate the red tab at the base of the power cord.
- Push the red tab using a small, flat-head screwdriver and pull the cord out of the control box.
- Dispose of the broken power cord.

- Insert new power cord into the control box
- Plug power cord back into wall outlet.

## TROUBLESHOOTING

Effect	Possible Cause	Verification	Corrective Action
Actuators are not working	Wire connections may be loose or damaged.  Hi/Lo lockout may be on.  Faulty actuator.	Visually check wire connections. They may be loose or frayed.  The light on the attendant control panel is on.  Disconnect power cord from bed that is not functioning and use on another bed that is functioning. Reconnect the power and test functions on that bed. A faulty actuator will not work with any connection port.	Reconnect any loose wires and/or power cords. If cord is frayed replace immediately. Unlock panel by pushing lock button and light should go off.  Contact Primus Medical 1-877-638-2776.
	Faulty pendant.	Check pendant cord connection, power supply, Hi/Lo lockout is off and pendant is not functioning. Disconnect pendant cord connection with a functioning pendant if available. Connect and test functions.	Contact Primus Medical 1-877-638-2776.
Bed stalls while operating	Thermal shut down.	Bed works for a short period of time the cuts out. Check for obstructions or any interference with bed frame, such as window seal or too much weight on bed frame.	Wait a period of time before using the bed frame again. DO NOT keep trying to override this will shorten the life of your product.
Bed is out of synchronization	The motor becomes unplugged.	The motor becomes unplugged and it gets plugged back in and the synchronization is off.	Hold the Hi/Lo buttons at the same time and wait for the bed to go down. The bed should now be in synchronization. If this does not work contact Primus Medical 1-877-638-

			2776.
Casters making ratcheting noise	Casters are locked	Casters are unlocked-make sure the left caster locks are facing up and the right caster locks are facing down.	Casters are unlocked-make sure the left caster locks are facing down and the right caster locks are facing up.
Bed moving slow	Power cord may be unplugged from wall outlet.	The power cord is not plugged into wall outlet. The bed is running off of the battery back-up.	Plug the power cord back into the wall outlet and bed should move at its normal speed.

## **Primus Medical, LLC Warranty**

Primus Medical Bariatric Bed, Model PPB1750, is guaranteed for a 3 year period from the date of delivery. This guarantee is against defects in materials and craftsmanship, under normal use and service.

This 3-year warranty includes electrical and mechanical parts and components. Welds are covered under lifetime<sup>1</sup> warranty of the product. Steel structural components are covered under the 15-year warranty from the date of delivery.

Damage caused by use in inappropriate environmental conditions, mistreatment or failure to maintain the product in agreement with user and service instructions is not covered under warranty.

Any change, adjustments, or repair unless performed or authorized in writing by Primus Medical, will void the warranty.

### **Parts**

Primus Medical beds contain a variety of parts that wear from normal use. Some products are not covered under the 3-year warranty but do fall under the 90-day warranty, such as DC batteries. Primus Medical's responsibility under this warranty is limited to supplying replacement parts, servicing or replacing, at its option, which is found to be faulty by Primus Medical.

Warranty replacement parts are covered by the warranty until the product's 3-year warranty period expires. For warranty replacement, Primus Medical requests that broken parts be sent back to them for evaluation. A credit will be issued only after the inspection.

### **Service**

A majority of service requests can be handled by the facility maintenance department with assistance from the Primus Medical tech support. If a Primus Medical technician is required one will be provided by Primus Medical at our discretion.

Most parts can be shipped next day air at the customer's expense.

This warranty is extended to the original purchaser of the equipment.

<sup>1</sup> Weld Lifetime is 20 years

ser# 11140109

PO 2606 Bought 1/27/12